



# LS SERIES

Lubricated Rotary Screw Air Compressors

125–200 hp ■ 90–160 kW

100/110/125/150/175/200 psi ■ 7/7.6/8.6/10.3/12/13.8 bar



\* Compared to previous models

LEGENDARY SULLAIR DURABILITY MEETS UNPRECEDENTED  
**SULLAIR PERFORMANCE**

**For more than 50 years, Sullair has built a reputation of durability.  
Put simply — Sullair compressors last.**

Sullair presents the LS Series of lubricated rotary screw compressors. These machines combine our heritage of durability and reliability, while adding unprecedented ease of use and performance benefits.

**Available in horsepower ranges from 125–200.**



- 
- The image is a dark, industrial-themed background. On the left, a large, cylindrical component is being rotated, with a spray of sparks or particles falling from it. On the right, a tall, multi-story industrial building with a grid-like facade is visible. The overall lighting is dim, with a greenish tint.
- **STEEL MILLS**
  - **TIRE PLANTS**
  - **AUTOMOTIVE**
  - **FORGING PLANTS**
  - **CHEMICAL PROCESSING**
  - **PAPER INDUSTRY**
  - **LARGE MANUFACTURING FACILITIES**

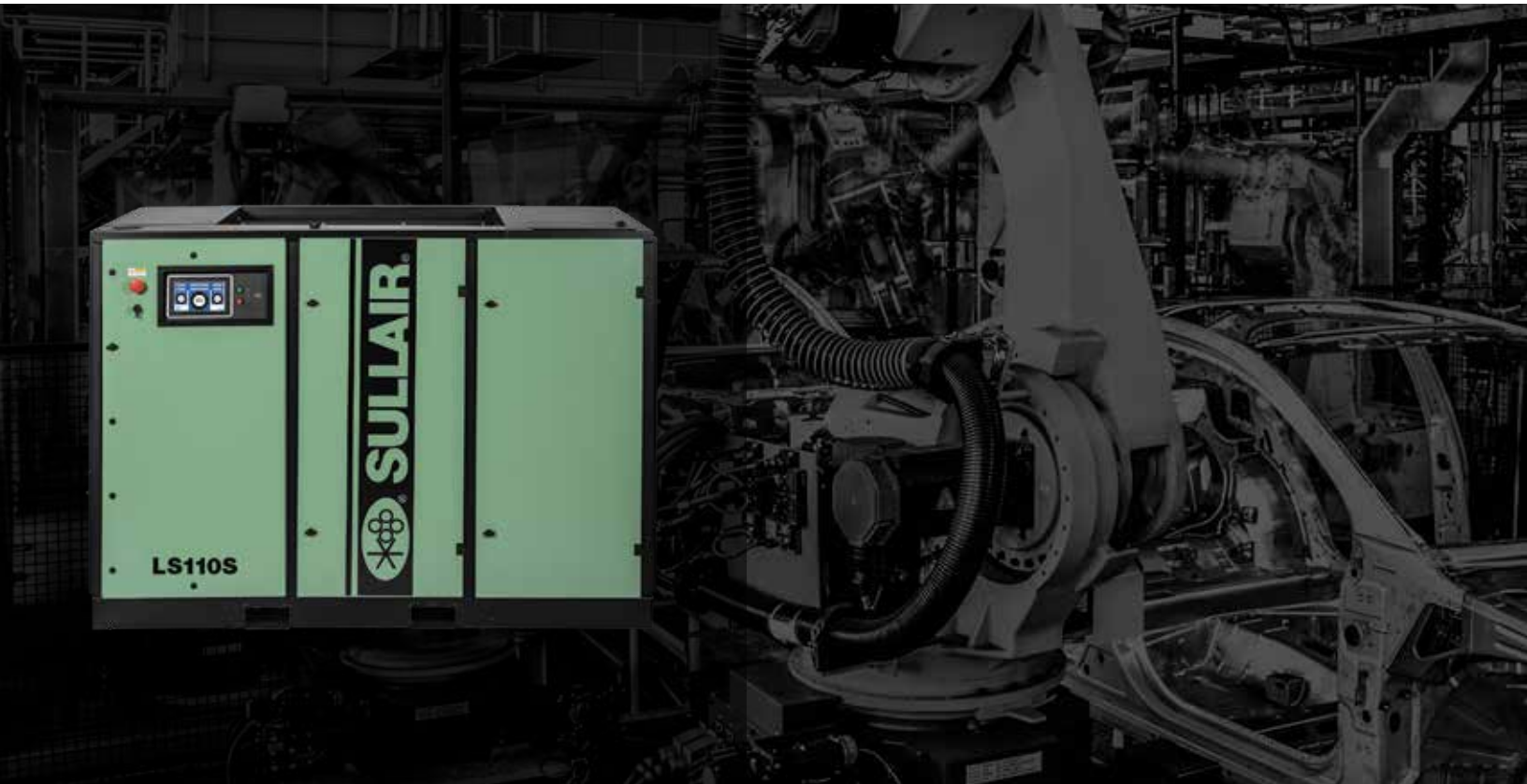

# PRECISION PERFORMANCE

## World-Class Efficiency

*Less energy to power your compressors means more savings*

- **Patent-pending Sullair Air End:** Designed to be the most efficient Sullair Air End ever
- **Sullair Electronic Spiral Valve Technology:** Proven Sullair Spiral Valve performance now with more precision and control to match capacity to system demand (*Optional feature*)
- **Variable Speed Drive:** Provides maximum energy efficiency and operating consistency by adjusting the speed of the motor to match compressed air supply needed (*Optional feature*)

## Ease of Use

*Easier and more intuitive operating and servicing*

- **10" Sullair Touch Screen Controller (STS):** provides easy access to all key compressor performance parameters
- **AirLinx® Remote Connectivity:** Remote monitoring of compressor functions is fast and easy from any connected device: computer, tablet or phone
- Enclosed unit features easily removable hinged door panels for streamlined service and maintenance

## Legendary Sullair Durability

*Expect more uptime, for a longer time*

- Patent-pending Air End has a simplified design, with the same bulletproof quality we've been producing for decades
- Standard TEFC motor offers increased protection against weather, dirt and moisture
- Slow running 1800 rpm motor provides longer life compared to faster rpm motors
- World-class components help ensure long life even under extreme operating conditions
- Standard full base frame, which helps keep dirt and dust out of the unit

# SULLAIR 10-YEAR DIAMOND WARRANTY

The Sullair 10-Year Diamond Warranty provides comprehensive protection for Sullair lubricated rotary screw air compressors. This program distinguishes itself by covering all major components for new air compressors (with discharge pressures up to 150 psi):

## 10-Year Coverage:

Sullair Air End

## 5-Year Coverage:

Main motor  
Fan motor  
Aftercooler  
Oil cooler  
Separator vessel  
Variable speed drive (if equipped)



Maintaining the Sullair 10-Year Diamond Warranty requires using Genuine Sullair parts and Sullube, as well as the oil sampling program. Restrictions apply.

## PERFORMANCE MATTERS

THE HEART OF A SULLAIR COMPRESSOR  
THE SULLAIR AIR END

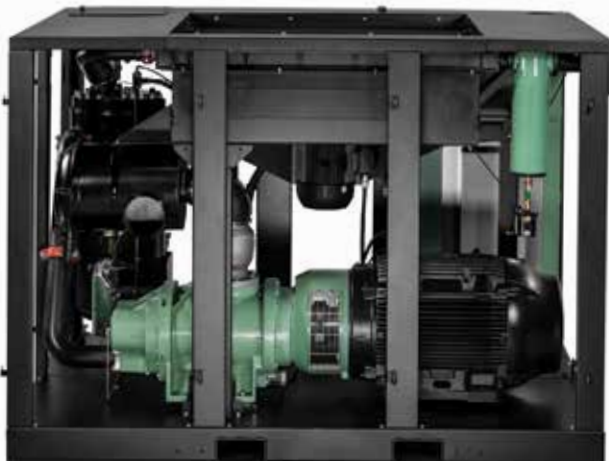

**Sullair has more than five decades with rotary screw technology and we keep finding ways to improve it.**

The new generation of Sullair Air Ends combines decades of experience in designing and manufacturing rotors – the most important part of the Air End – with the latest in research and technology. Our patent-pending new generation Air End continues to feature asymmetrical rotors precision milled for ultimate performance. And now the Sullair Air End includes:

- Simpler design for increased uptime. Sullair engineers have developed the latest generation of Air Ends with the optimal number of parts using new casting technologies
- Larger rotor profile (230mm) for increased efficiency
  - LS160 models up to 150 psi (10.3 bar)<sup>1</sup> feature an enhanced Air End package with 260mm rotor profile and improved inlet valve design boosting free air delivery and increasing efficiency compared to previous models

The result? The highest performing Sullair Air End. Ever. All without sacrificing the durability Sullair is known for.

<sup>1</sup> LS160V models only feature the enhanced Air End package up to 125 psi (8.6 bar)

# FEATURES THAT PERFORM. BENEFITS THAT COUNT.

*A Sullair compressor is much greater than the sum of its parts. The LS90, LS110 and LS160 all feature patent-pending package designs, in which all components are specially designed, engineered and manufactured to perform at the highest levels.*



## 1. Sullair OptimalAir® Air Filter

- High-efficiency/heavy-duty inlet filter holds up to five times more contaminant than conventional cellulose filters
- Cleaner intake air keeps fluid clean and extends component life
- 99.9% efficiency per ISO 5011

## 2. Air End *(Patent-Pending)*

At the heart of all Sullair compressors are our Air Ends, known worldwide for their durability. The new Sullair design features:

- All new casting featuring internally ported lubricant passages
    - Asymmetrical rotors designed, engineered and manufactured in the USA
  - Proven bearing design to extend bearing life
- 2a.** LS160 models up to 150 psi (10.3 bar<sup>1</sup>) feature the enhanced Air End package including an improved inlet valve design

Sullair Air Ends are protected by the exclusive Diamond Warranty for 10 years<sup>2</sup>

## 3. Sullair Air-Fluid Separator

- Designed for low pressure drop which helps save energy
- High-efficiency media helps maximize oil removal from compressed air
- Low carryover (<2ppm) means fewer lubricant top-offs needed
- ASME and CRN approved

## 4. Cooling System

- Heavy-duty, oversized cooling system designed for 46°C (115°F) applications
- Easy-clean access panels designed in the package
- Separate oil cooler and aftercooler reduces imbalanced temperature loads

## 5. Motor

- TEFC premium efficient motor
- Heavy-duty, slow-running 1800 rpm design
  - Extended life when compared to higher rpm motors
- Class F insulation, Class B rise for higher temperature operation

<sup>1</sup> LS160V models only feature the enhanced Air End package up to 125 psi (8.6 bar)



<sup>2</sup> Sullair Diamond Warranty applies to compressors with operating pressures up to 150 psi

## Capacity Control Options

- **Electronic Spiral Valve:** Proven Sullair Spiral Valve Technology — now with electronic precision and control to more tightly match supply to system demand
- **Variable Speed Drive (VSD):** Provides maximum energy efficiency and operating consistency by adjusting motor speed to match compressed air supply needs

## Highest Quality Lubricants

- Genuine Sullube® powered by Dow Technology standard
  - 10,000-hour, non-varnishing fluid protects and cleans your compressor
  - Polyglycol base provides optimal viscosity and helps optimize operating temperatures
- Optional PristineFG™ food-grade lubricant

## Sullair Touch Screen (STS) Controller

- 10" color screen for easy viewing and intuitive operation
- Menu-driven screens offer easy access to compressor controls
- Integrated graphing and trending to analyze compressor performance
- Sequencing up to 16 compressors

## AirLinx® Remote Monitoring

- Connect anywhere to keep an eye on compressor operation, and reduce the risk of unplanned downtime
- Monitor pressure, temperature, running hours and service hours
- Alerts for service and warnings
- Data stored at 15-minute intervals
- Customizable reporting, from basic to advanced
- Real-time information through cellular connection

## Plus — the following features are standard on the LS Series:

- Wye-Delta starter
- Zero loss drain
- Phase monitor
- Enclosure with hinged panels — easily removable for service
- Full floor to help keep dust and debris out

# CAPACITY CONTROL OPTIONS

## ELECTRONIC SPIRAL VALVE

COMPRESSOR PERFORMANCE COMPARISON

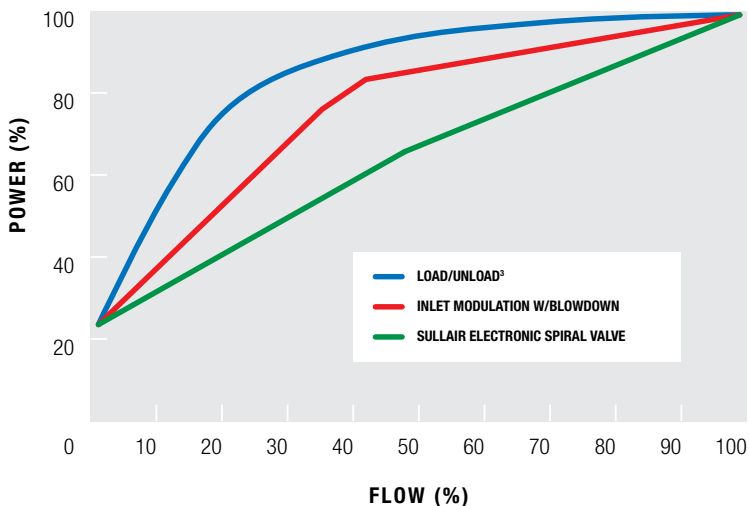

*The costs to operate an air compressor — especially energy costs — can quickly exceed the initial purchase price. Effectively matching compressor production capacity to your facility needs is the best way to save both energy and money.*

Comparison powered by **AirSuite**

<sup>3</sup> L/UL curve assumes 1 gal/cfm storage; 30 second blowdown  
All power curves calculated using CAGI data.



## Sullair Electronic Spiral Valve Controls

Electronic spiral valve controls are now available with Sullair compressors. This feature combines the performance and reliability Sullair is known for in spiral valve technology with the ease and precision of touch screen controls.

Spiral valve technology represents an energy-efficient control scheme which matches compressor displacement to demand without reducing inlet pressure. Managed by the Sullair Touch Screen Controller, the electronic spiral valve maintains a tight 1 psi control band — closely matching machine supply to demand need.

## Variable Displacement Air End

Compressors with electronic spiral valve feature a variable displacement Air End. Compression volume is varied to suit air demand by progressively opening or closing internal bypass ports on the Air End.

- Closed bypass ports utilize the entire length of the rotor and compression chamber
- Partially open and open bypass ports reduce the length of the rotor used for air compression, which in turn utilizes less energy

## Spiral Valve Benefits

- Capacity is matched to system demand, reducing cycling time and extending component life
- Multiple spiral valve compressors may be sequenced to operate in synchronous fashion
- Up to 55% turndown capability with electronic spiral valve
- Outstanding energy efficiency in all operating conditions including:
  - High elevation
  - Dirty environments



**BYPASS PORTS IN STATOR**

*Rotors removed to show bypass ports*

### CLOSED BYPASS PORTS

When the bypass ports are closed, the full compression chamber is used.



### PARTIALLY OPEN BYPASS PORTS

With the bypass ports partially open — the compression chamber is shortened. Less intake air is fully compressed — saving energy.



### OPEN BYPASS PORTS

Fully open bypass ports further shorten the compression chamber providing maximum turndown.



*The Sullair LS Series is the first to offer electronic spiral valve operation with Sullair compressors. Electronic spiral valves offer more precision when compared to manually operated spiral valves.*

# CAPACITY CONTROL OPTIONS

## VARIABLE SPEED DRIVE

## MAXIMIZE ENERGY EFFICIENCY AND OPERATING CONSISTENCY

*Variable Speed Drive (VSD) allows a compressor to automatically adjust motor speed, matching output to demand.*

### Sullair Compressors with VSD Provide:

- Excellent energy savings — only compressed air needed is produced
  - Relief from potential peak demand charges
  - Possible utility company rebates
- Flexibility for future growth — both capacity and pressure may be varied
- Lowest life-cycle cost
- DC link choke
- Stable system pressure
  - Helps ensure consistent product quality
  - Reduced system air leaks
  - Reduced storage requirements

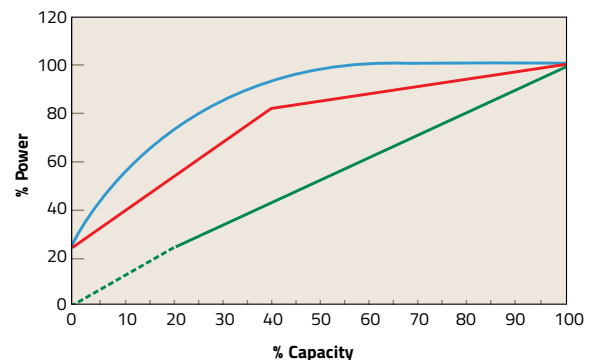

— Single-Stage Lubricated Load/Unload (based on one gallon/storage per cfm)  
— Single-Stage Lubricated Inlet Modulation with Blowdown  
— Single-Stage Lubricated Variable Speed

Reference: Compressed Air and Gas Handbook, 6th Edition, pages 221-223.

*The chart is a representation of nominal control systems for generic comparative purposes. A detailed and accurate comparison of specific compressor models is available from your authorized distributor.*

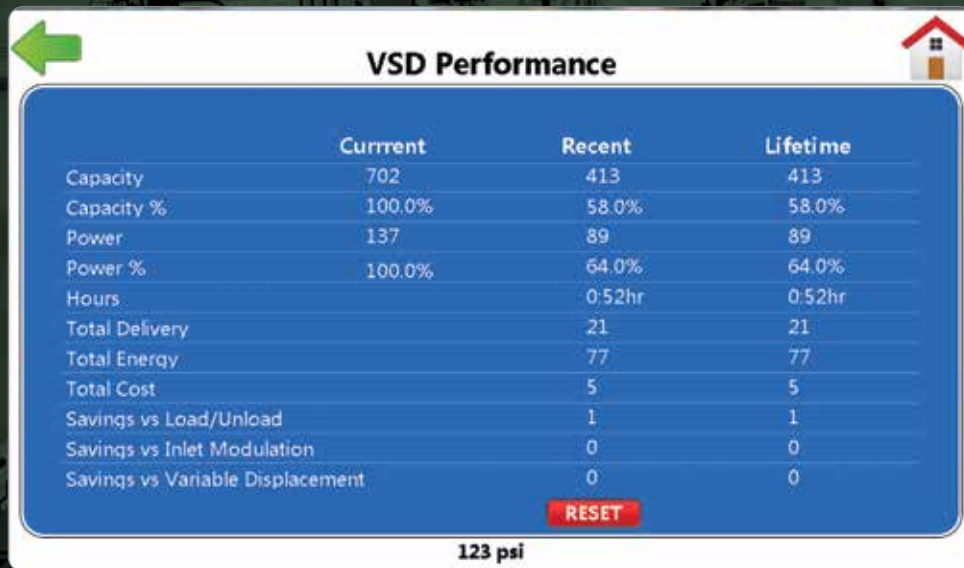

## YOUR COMPRESSED AIR SYSTEM CAN IMPROVE YOUR BOTTOM LINE:

### 35% Energy Savings Potential in the First Five Years

In just five years, the electrical power cost to operate a standard compressor can be more than six times greater than its purchase price.

### Total Compressor Flexibility

Sullair VSD compressors provide flexibility to vary both capacity and pressure. This allows you to “grow” your air system without adding more compressors.

### Soft Start is Standard with Unlimited Starts and Stops

- No need for Wye-Delta and other soft starters
- No need to control the number of hot or cold starts
- Unlimited starts and stops save electrical costs
- Avoids high electrical current at start-up

# ULTIMATE IN USER CONTROL

The Sullair Touch Screen (STS) Controller utilizes a large 10" color screen for easy viewing in any lighting condition

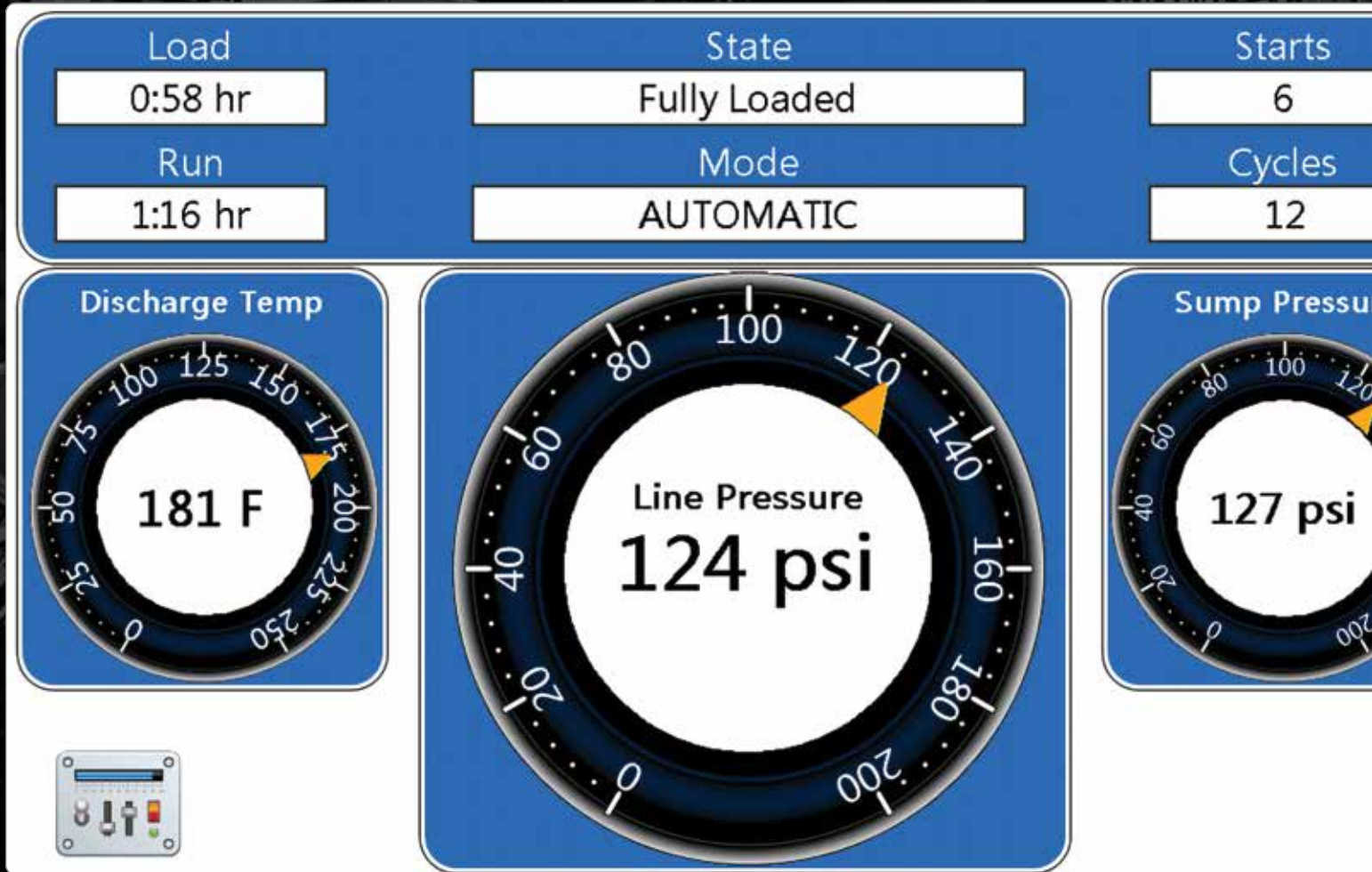

Actual Size

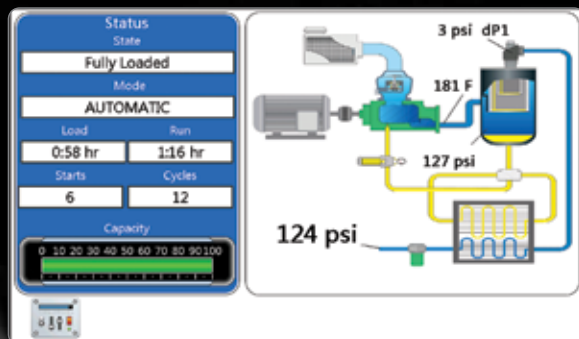

Optional Mimic Screen

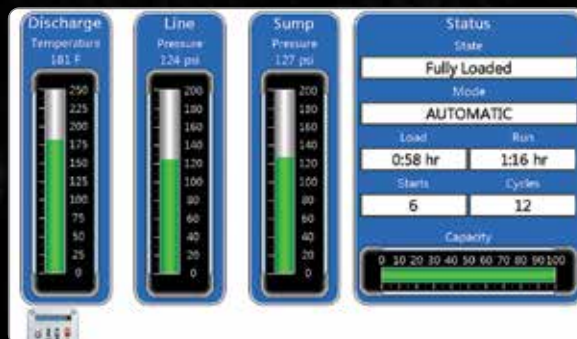

Optional Analog/Digital Screen

### Menu-driven screens provide easy access to all compressor controls

- Support for sequencing up to 16 compressors
- More communication capabilities: Ethernet, ModBus RTU and ModBus TCP, Cellular (AirLinx® service)
- Remote access capability via VNC (Virtual Network Computing) protocol
- Start/Stop scheduling with pressure control
- NEMA 4 environmental protection
- Discreet Start and Stop 22mm buttons
- Bright operating status LEDs even when display is dimmed
- Expandable I/O for additional sensor monitoring and output control
- Electronic spiral valve control for precise pressure regulation
- Supports power monitoring
- Trend graphing of operational parameters
- Most controller functions and adjustments via protected controller submenus
- New data download capabilities

### AirLinx® Remote Monitoring

AirLinx enables you to stay connected to your compressor operations wherever you are. It provides automated service and fault alerts, as well as access to a portal where system performance can be viewed. AirLinx helps reduce the risk of unplanned downtime and ensures timely service.

### AirLinx® service features

- Pressure monitoring
- Compressor temperature monitoring
- Running hours and service hours monitoring
- Running hours monitoring
- Alerts for service and warning breakdowns
- Data stored at 15-minute intervals

### Provides VSD load profile graphing capabilities

- One year of data retained on the cloud

### AirLinx can be customized to provide different service levels

- **Basic:** Email and text notifications for fault and warning conditions
- **Advanced:** Tracking and visualizing all relevant performance parameters with reporting tools to support the management of the compressor system





# OPTIMIZING YOUR COMPRESSED AIR OPERATIONS

## Sullair Air Treatment

A well-designed air treatment system has a number of critical stages, each contributing to the goal of clean, dry air. Sullair provides a comprehensive portfolio of options to help you achieve your air quality objectives.

- **Dryers** — refrigerated and desiccant — with flow capacities from 3 to 10,000+ cfm, to help keep moisture out of your compressed air system
- **Filtration and Mist Eliminators** — designed to help keep contaminants out of the air stream
- **Oil/Water Separators** — designed to manage condensate discharge
- **Drains** — designed to remove condensate from compressors, dryers and filters
- **Flow Controllers** — designed to help minimize significant fluctuations in compressed air supply and demand



*Energy costs associated with compressed air operations are typically one of the largest expenditures in a facility.*

*The US Department of Energy (DOE) has estimated that on average more than 50% — or \$20,000 — of the energy costs to run one 100 hp air compressor is wasted.*

A Sullair air audit can help maximize your compressed air investment by identifying savings throughout your operations. It helps ensure the right compressor, air treatment, piping and other features are properly specified — both today and in the future.

Sullair air audits are detailed reports providing information necessary to make sound decisions based on facts. Tailored around DOE standards, Sullair air audits review the entire compressed air system, from supply to distribution to use.

# GENUINE PARTS. ORIGINAL LUBRICANTS.

The patent-pending package design of the new Sullair LS Series of compressors includes Sullair Genuine Parts and Sullair Original Lubricants designed, formulated and manufactured to optimize the operation of your Sullair compressor. Use of Sullair Genuine Parts and Sullair Original Lubricants helps keep your compressor operating efficiently while protecting your warranty.

## Sullair Genuine Parts

Sullair Genuine Parts included in the new Sullair LS Series include:

- OptimalAir® Air Filter Element
  - High-efficiency/heavy duty inlet filter features 99.9% overall efficiency (per ISO 5011)
  - Cleaner air entering the compressor helps extend the life of the Air End, oil filter, lubricant and separator
- Sullair Oil Filters — designed to remove contaminants — extending the life of your compressor lubricant while helping protect internal components

*Contact your authorized Sullair distributor to learn more about Sullair Genuine Parts available for your Sullair compressor.*





### **Sullair Service and Support**

When you invest in a Sullair air compressor, you get more than just an asset in your facility. You get global service and support.

### **Sullair Authorized Distributors**

Sullair Authorized Distributors span the globe and provide local service and support before, during and after the sale. Sullair Authorized Distributors provide:

- Sales and installation of complete compressed air systems and packages
- Air audits
- Preventive maintenance and service
- Emergency service
- And more

Sullair Authorized Distributors are your source for Sullair Genuine Parts and Genuine Sullair Fluids.

### **Sullair Service Department**

The Sullair service department provides responsive, knowledgeable service, including on-site and factory-based technical assistance to Sullair customers around the globe.

### **Genuine Sullube® by Sullair**

Sullube is an extended-life, polyglycol base, synthetic fluid for stationary rotary screw air compressors. With advanced formulation powered by Dow Technology, Genuine Sullube is the standard factory fill for Sullair LS Series air compressors. Proven for more than a quarter century, this long-lasting fluid costs less per hour over your compressor's life.

Sullube prevents the formation of varnish — the leading cause of Air End failure among rotary screw compressors — and keeps your compressors running exceptionally clean and cool. And a well-running compressor is key to maintaining an efficient operation with more uptime.

- One of the longest useful lives in the industry — up to 10,000 hours
- High flash point means reliable and safe operation
- High thermal conductivity helps dissipate heat
- Environmentally friendly — in-compressor condensate is biodegradable

### **Optional Lubricants**

PristineFG™ Food Grade Lubricant is designed for use in food, beverage and pharmaceutical applications. It meets USDA and FDA H1 requirements for use in food processing areas. PristineFG lasts up to 6000 hours, one of the longest useful lives of any food grade lubricant available.

# ABOUT SULLAIR

For more than 50 years, Sullair has been on the leading edge of compressed air solutions. We were one of the first to execute rotary screw technology in our air compressors, and our machines are famous all over the world for their legendary durability. As the industry moves forward, Sullair will always be at the forefront with quality people, innovative solutions, and air compressors that are built to last.

*Sullair was founded in Michigan City, Indiana in 1965, and has since expanded with a broad international network to serve customers in every corner of the globe. Sullair has offices in Chicago and manufacturing facilities in the United States and China — all ISO 9001 certified to ensure the highest quality standards in manufacturing. In addition, the Sullair Suzhou facility is ISO 14001 and OHSAS 18001 certified.*

**Sullair is A Hitachi Group Company**



**LUBRICATED ROTARY SCREW**



**OIL FREE SCROLL AND ROTARY SCREW**



**TWO-STAGE LUBRICATED ROTARY SCREW**

**RELIABILITY.  
DURABILITY.  
PERFORMANCE.**

*These are the pillars that drive the quality of Sullair compressors. It's a promise we keep with every machine we make.*

# RELIABILITY

Customers who work with Sullair have found that the intangibles make all the difference — things like trust, confidence, and peace of mind. They go to work every day having full faith in their equipment, as well as the knowledge that dedicated distributors and Sullair personnel have their back every step of the way.

# DURABILITY

Bulletproof. Built to last. However you spin it, Sullair compressors are in it for the long haul, driven by the design of the legendary Air End. In factories and shops all over the world, you'll find Sullair compressors that have stood the test of time, running consistently today like they did on day one.

# PERFORMANCE

You have high expectations for your operations, and we make machines that share your work ethic. Sullair compressors do what they're supposed to do, and they do it extremely well for a very long time. And working with us means not only access to clean, quality air, but also the tools you need to optimize this vital resource.



**OIL FREE CENTRIFUGAL**



**ROTARY SCREW VACUUM**



**AIR TREATMENT**

# PRODUCT INFORMATION

FOR MORE INFORMATION, CONTACT YOUR LOCAL SULLAIR AUTHORIZED DISTRIBUTOR.

SPECIFICATIONS			FREE AIR DELIVERY**											
MODEL	MOTOR		100 psi	7.0 bar	110 psi	7.6 bar	125 psi	8.6 bar	150 psi	10.3 bar	175 psi	12.0 bar	200 psi	13.8 bar
	hp	kW	acfm	m <sup>3</sup> /min	acfm	m <sup>3</sup> /min	acfm	m <sup>3</sup> /min	acfm	m <sup>3</sup> /min	acfm	m <sup>3</sup> /min	acfm	m <sup>3</sup> /min
LS90	125	90	—	—	634	18.0	594	16.8	523	14.8	469	13.3	—	—
LS90S	125	90	—	—	634	18.0	594	16.8	523	14.8	469	13.3	—	—
LS90V	125	90	—	—	625	17.7	594	16.8	512	14.5	459	13.0	—	—
LS110	150	110	—	—	763	21.6	702	19.9	622	17.6	568	16.1	—	—
LS110S	150	110	—	—	763	21.6	702	19.9	622	17.6	568	16.1	—	—
LS110V	150	110	—	—	743	21.1	702	19.9	617	17.5	559	15.8	—	—
LS160	200	160	1070	30.3	1025	29.0	985	27.9	875	24.8	—	—	734	20.8
LS160S	200	160	1070	30.3	1025	29.0	985	27.9	875	24.8	—	—	734	20.8
LS160V	200	160	1070	30.3	1025	29.0	985	27.9	869	24.6	—	—	729	20.6

Highlighted models feature 260mm rotor profile.

\*\* acfm measured in accordance with ISO1217, Annex C

DIMENSIONS								
MODEL	LENGTH		WIDTH		HEIGHT		WEIGHT	
	in	mm	in	mm	in	mm	lbs	kg
LS90	99	2509	69	1760	70	1773	5830	2650
LS110	99	2509	69	1760	70	1773	6007	2730
LS160	118	2997	76	1930	74	1880	7515	3416

FEATURE	STANDARD	OPTIONAL
Lubricant	Sullube®	PristineFG™ Food Grade
Enclosure	Enclosed	Open
Capacity Control Options	—	Electronic Spiral Valve or VSD
Starter/Starter Box	Wye-Delta/NEMA 4	—
Cooling	Air Cooled	Water Cooled
Drain	Zero Loss	—
Motor	TEFC	—
Controls	10" Sullair Touch Screen	—
Remote Monitoring	AirLinx®	—
Electrical Protection	Phase Monitor Surge Protection	—
Additional Options	—	Water Regulation Valve Water Solenoid Valve 55°C Package Weather Hood
Cold Weather Options	—	Control Box Heater Frost Free Trap Heater